

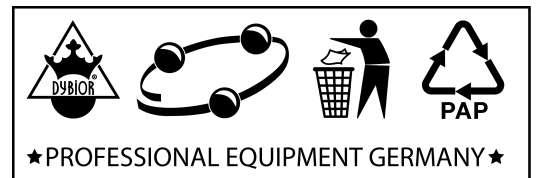

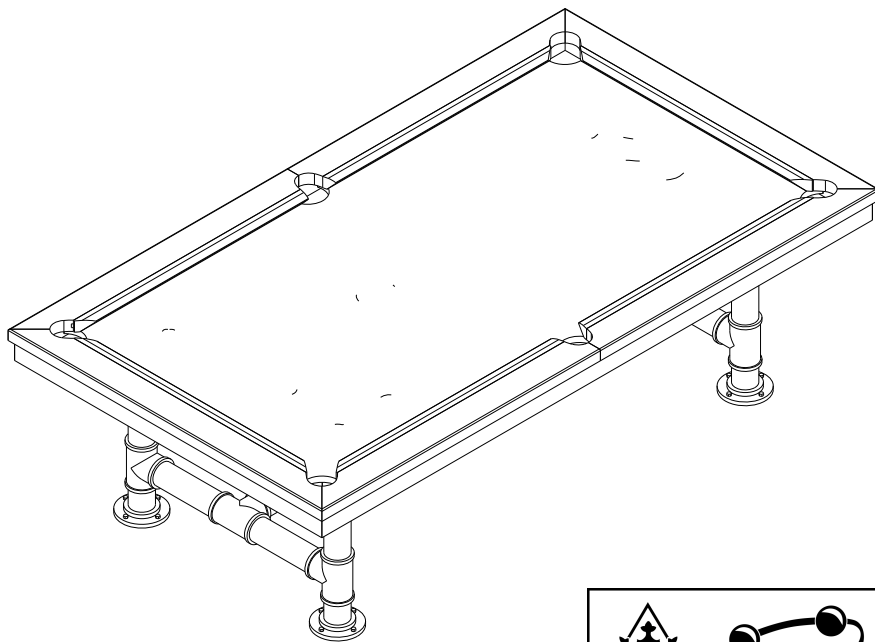













7&8' BEDFORD











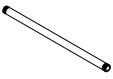
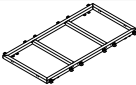

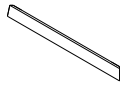

BEDFORD TABLE
ASSEMBLY INSTRUCTIONS
AUFBAUANLEITUNG

BEDFORD HARDWARE

PACKAGE	ITEM#	SAMPLE	DESCRIPTION	QTY.
LEG/PANEL	H1		HEX HEAD CROSS BOLT 1/2" X 1-3/16"(M12X30mm)	4
	H2		FLAT WASHER 1/2" I.D.	4
BEAM/BLOCK	H3		HEX HEAD CROSS BOLT 5/16" X 3-1/8"(M8X80mm)	16
	H4		FLAT WASHER 5/16" I.D.	16
RAIL/POCKET/SLATE	H5		FLAT HEAD SCREW 1/4" X 2"(M6X50mm)	12
	H6		STUD BOLT 5/16" X 5-1/2"(M8X140mm)	2
	H7		STUD BOLT 5/16" X 3-1/2"(M8X88mm)	4
	H8		FLAT WASHER 5/16" I.D.	12
	H9		HEX NUT 5/16" I.D.	12
	H10		HEX HEAD CROSS BOLT 5/16" X 1"(M8X25mm)	16
	H11		FLAT WASHER 5/16" I.D.	16
	H12		HEX HEAD CROSS BOLT 5/16" X 1-7/16"(M8X36mm)	12
	H13		FLAT WASHER 5/16" I.D.	12
	H14		HEX HEAD CROSS BOLT 3/8" X 2-3/8"(M10X60mm)	18
	H15		DOME WASHER 3/8" I.D.	18
	H16		FLAT HEAD SCREW 5# X 1/2"(M3X12mm)	24

BEDFORD COMPONENT PARTS

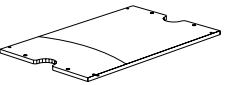
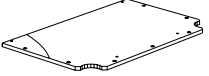
PACKAGE	ITEM#	SAMPLE	DESCRIPTION	QTY.
LEG	1		LEG	2
	2		LEG CENTER BEAM	1
FRAME(PANEL)	3		CABINET	1
	4		LONG WOODEN BLOCK	4
	5		SHORT WOODEN BLOCK	4
	6		SIDE APRON	2
	7		END APRON	2
	8		APRON JOINT CORNER BLOCK	4
TOP RAIL	9		TOP RAIL LEFT SIDE	2
	10		TOP RAIL RIGHT SIDE	2
	11		TOP RAIL END	2
POCKET	12		SIDE POCKET	2
	13		CORNER POCKET	4
SLATE	14		SLATE (LEFT)	1
	15		SLATE (CENTER)	1
	16		SLATE (RIGHT)	1

BEDFORD COMPONENT PARTS



PACKAGE	ITEM#	SAMPLE	DESCRIPTION	QTY.
	17		CLOTH	1
	18		WOOD JOINT	4

FIG.1



* Adjust the height of leg(1).

FIG.2

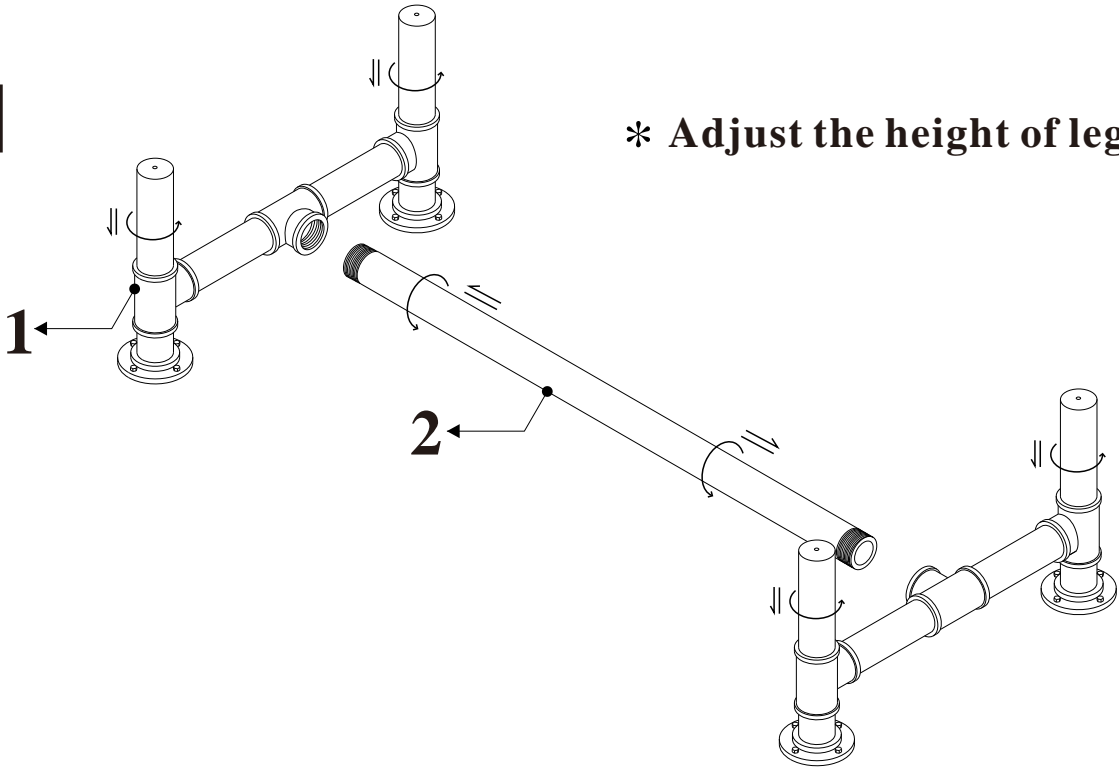
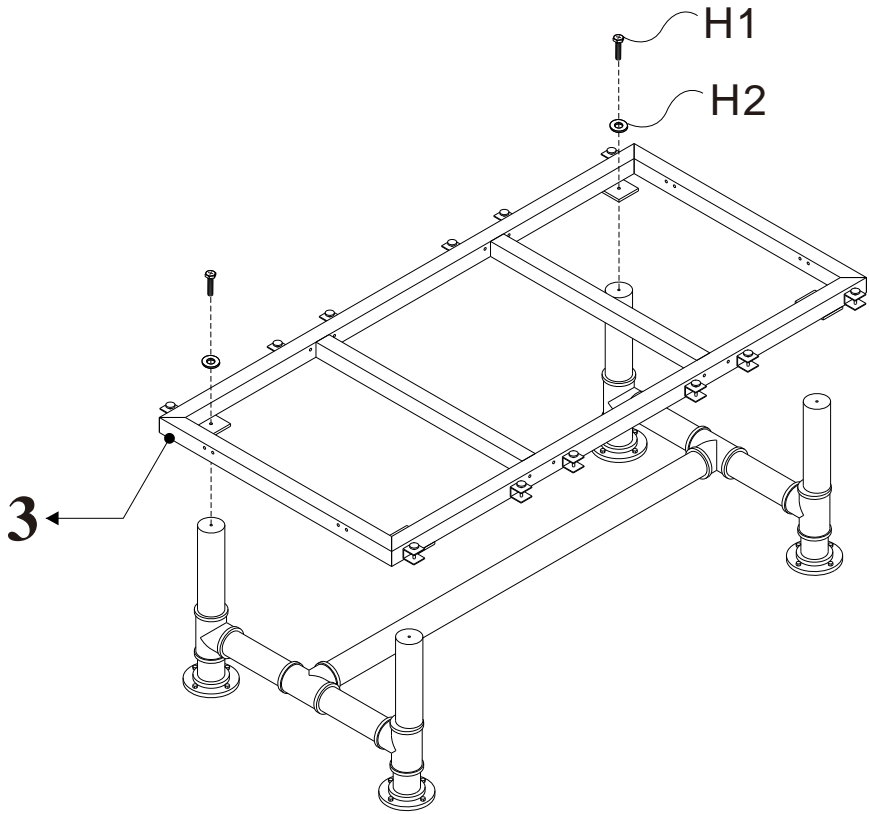

FIG.3

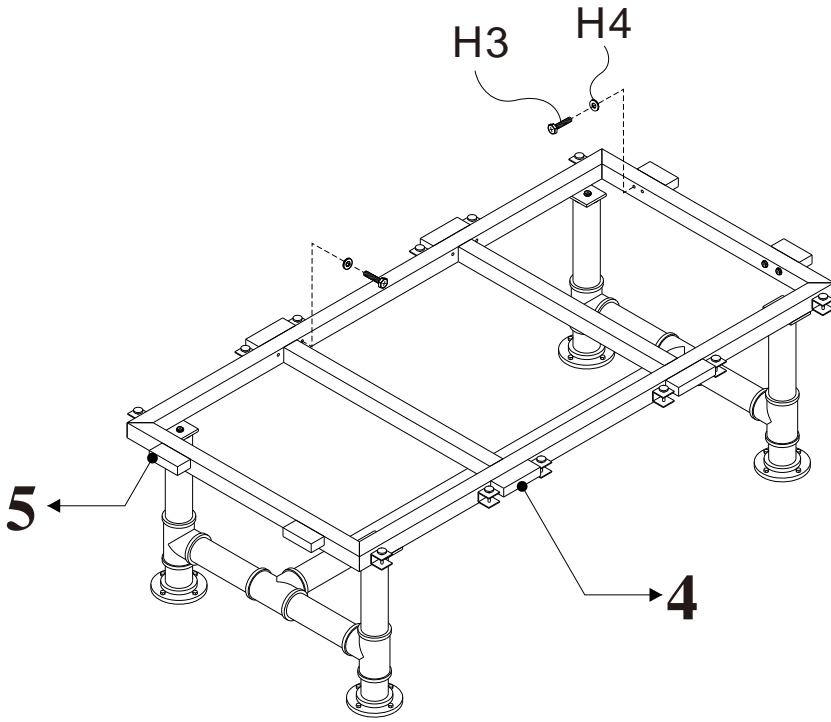

FIG.4

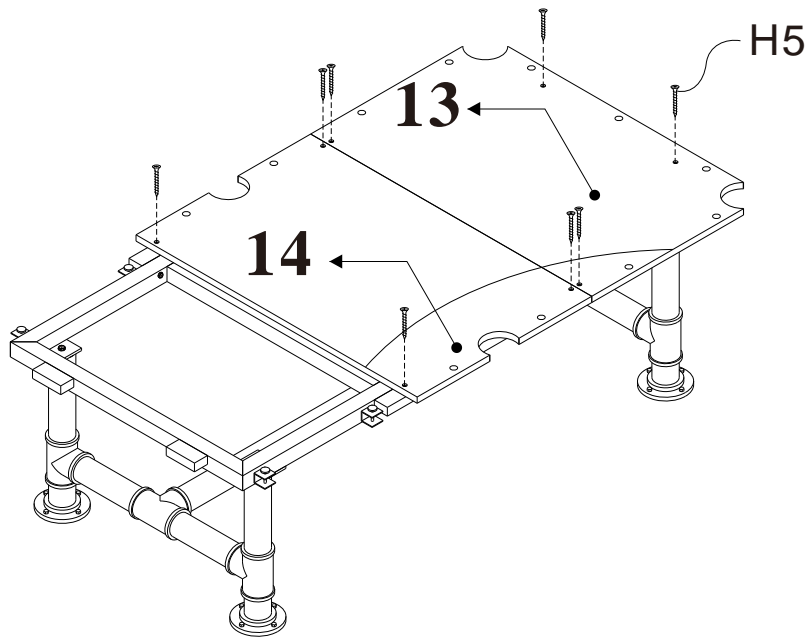
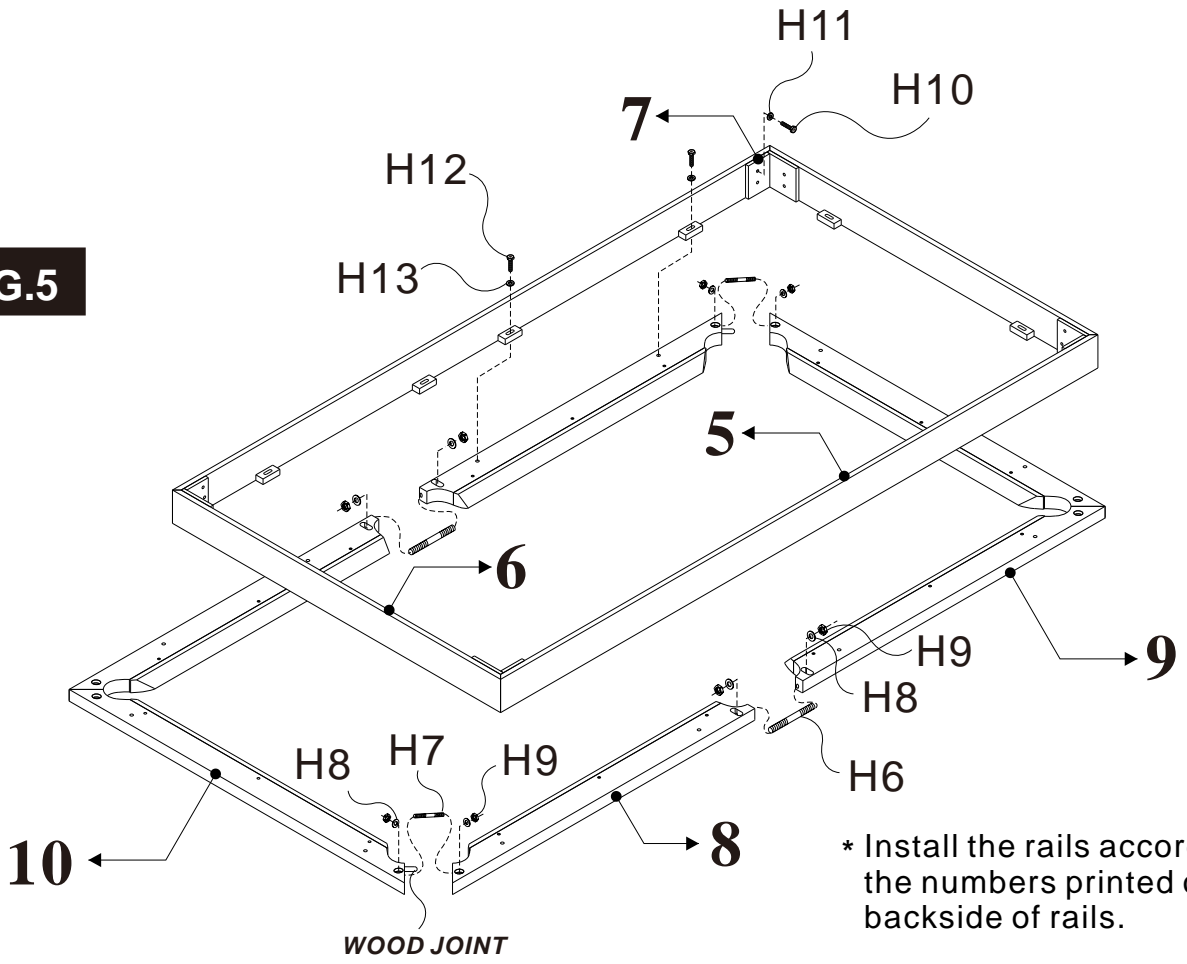

FIG.5



Finish

